

Service
Service
Service

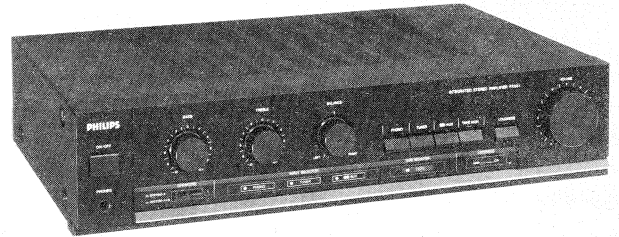

40 049 A

Service Manual

Table of contents	Page
Specifications	2
Connections and controls	3
Adjustments, standard symbol list	4
Semi conductor layout	5
Schematic diagrams	6,7,8
Wiring diagram	9,10,11,12
Exploded view, list of mechanical parts	13,14
List of electrical parts	15

(GB)

Safety regulations require that the set be restored to its original condition and that parts which are identical with those specified be used.

(F)

Les normes de sécurité exigent que l'appareil soit remis à l'état d'origine et que soient utilisées les pièces de rechange identiques à celles spécifiées.

(NL)

Veiligheidsbepalingen vereisen, dat het apparaat in zijn oorspronkelijke toestand wordt teruggebracht en dat onderdelen, identiek aan de gespecificeerde worden toegepast.

(D)

Bei jeder Reparatur sind die geltenden Sicherheitsvorschriften zu beachten. Der Originalzustand des Geräts darf nicht verändert werden für Reparaturen sind Original-Ersatzteile zu verwenden.

(I)

Le norme di sicurezza esigono che l'apparecchio venga rimesso nelle condizioni originali e che siano utilizzati pezzi di ricambio identici a quelli specificati.



SPECIFICATION	Nominal value	Typical value
General		
Mains voltage	: 220V ~ (/00R) : 240V ~ (/05R)	: 220V ~ (/00R) : 240V ~ (/05R)
Mains frequency	: 50 – 60 Hz	: 50 – 60 Hz
Power consumption	: 145W max	: 25 – 145W
Dimensions (WxHxD)	: 420 x 90 x 260 mm	: 420 x 90/96 x 260 mm
Weight	: 3.9 kg	: 3.9 kg
Amplifier		
Output power	: 28W in 8Ω (IEC)	: 28W in 8Ω (IEC)
Distortion		
T.H.D.	: ≤ 0.3% at 1 kHz : ≤ 0.3% at 63 Hz–12.5 kHz } (IEC) : ≤ 0.3% at 60/7000 Hz 4:1 }	: ≤ 0.1% at 1 kHz : ≤ 0.3% at 63 Hz–12.5 kHz } (IEC) : ≤ 0.1% at 60/7000 Hz 4:1 }
Intermodulation		
Frequency characteristic		
Phono input } tone control	: from 20 Hz – 20 kHz ±2 dB (IEC)	: from 20 Hz – 20 kHz ±1 dB (IEC)
Other inputs } neutral	: from 20 Hz – 20 kHz ±2 dB	: from 10 Hz – 25 kHz ±2 dB
Bass control	: at 100 Hz +10 dB to –10 dB ±2 dB	: at 100 Hz +10 dB to –10 dB
Treble control	: at 10 kHz +10 dB to –10 dB ±2 dB	: at 10 kHz +10 dB to –10 dB
Loudness	: at 100 Hz +6 dB ±3 dB } Tap : at 10 kHz +4 dB ±2 dB } position	: at 100 Hz +6 dB } Tap : at 10 kHz +3 dB } position
Signal/noise ratio weighted (A-curve)		
Phono input	: for 28W output ≥ 75 dB (IEC)	: for 28W output ≥ 75 dB (IEC)
Other inputs	: for 28W output ≥ 90 dB (IEC)	: for 28W output ≥ 90 dB (IEC)
Channel separation	: at 1000 Hz ≥ 45 dB : at 250 Hz – 10 kHz ≥ 35 dB	: at 1000 Hz ≥ 60 dB : at 250 Hz – 10 kHz ≥ 40 dB
Input sensitivity		
Phono	: 2.5 mV at 47 kΩ	: 2.5 mV at 47 kΩ
Tuner	: 150 mV at 24 kΩ	: 150 mV at 25 kΩ
Tape	: 150 mV at 24 kΩ	: 150 mV at 25 kΩ
CD/AUX	: 150 mV at 24 kΩ	: 150 mV at 25 kΩ
Outputs		
Tape	: 350 mV at 1 kΩ (Phono 7.75 mV 1 kHz input)	: 150 mV

Caution  **220V/240V**



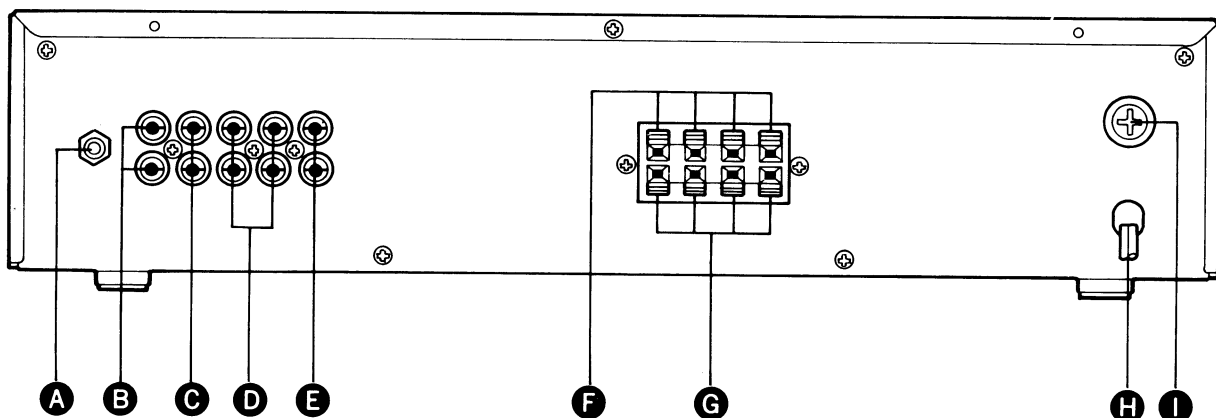
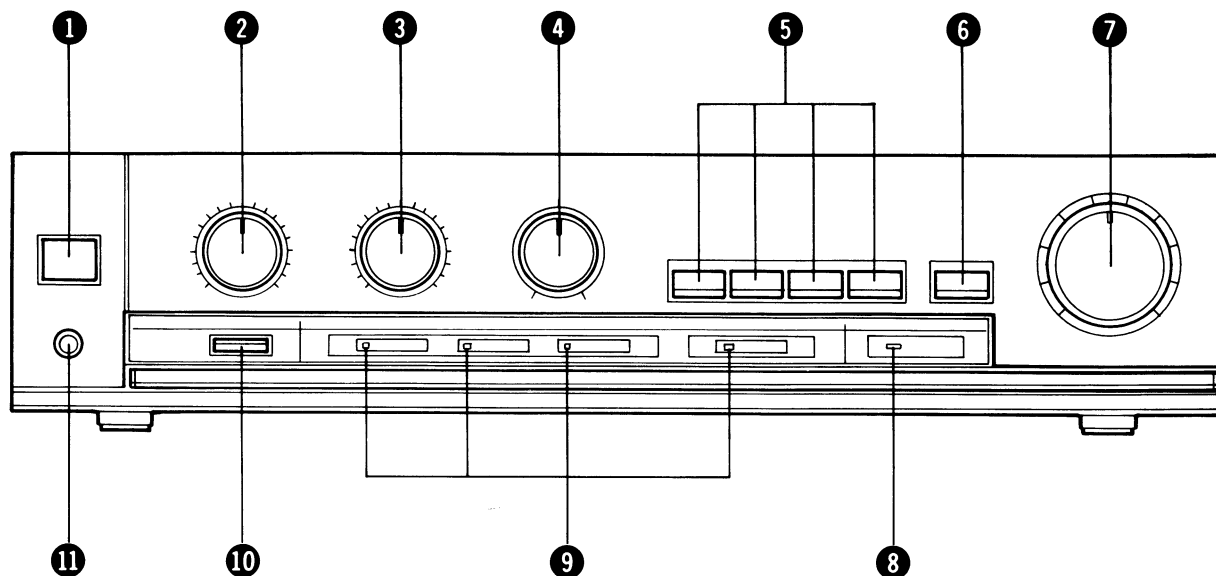



Removal of upper cabinet and recordplayer exposes the protruding current-carrying parts of mains switch and mains transformer, therefore extreme care should be taken when the apparatus is connected to the mains.



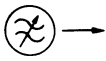

CONNECTIONS AND CONTROLS

1	Mains switch	S001	A	Ground terminal	J031
2	Bass control	RE15	B	Phono input	} JS06
3	Treble control	RE16	C	CD/Aux input	
4	Balance control	RE52	D	Tape input/output	} JS07
5	Function switch	} SS01	E	Tuner input	
6	Loudness switch		RG01	F	LS output A
7	Volume control	DL55	G	LS output B	
8	Loudness indicator	DL51~DL54	H	Mains cord	W001
9	Function indicator	SW01	I	Fuse holder	J001
10	LS switch				
11	Headphone socket	JS01			

Idling Current

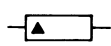
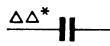
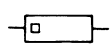
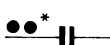
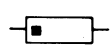
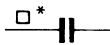
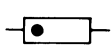
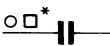
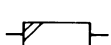
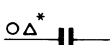
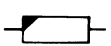
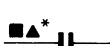
SK... SWITCH	 SIGNAL	 TO	 VOLUME	 ADJUST	 OSCILLOSCOPE	 D.C. METER INDICATOR
			Min.	Lch RB02(L)		Lch TP1(+), TP3(-) DC 4 mV (20 mA)
				Rch RB02(R)		Rch TP2(+), TP4(-) DC 4 mV (20 mA)

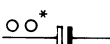
	Carbon film 0.125 W or 0.2 W	70°C	5%		Ceramic plate Tuning ≤ 120 pF NP.0 2% Others -20/+80%	*a = 2.5 V b = 3.15 V or 4 V c = 6.3 V d = 10 V e = 16 V f = 25 V g = 40 V h = 63 V j = 100 V l = 125 V m = 150 V n = 160 V q = 200 V r = 250 V s = 300 V t = 350 V u = 400 V v = 500 V w = 630 V x = 1000 V A = 1.6 V B = 6 V C = 12 V D = 15 V E = 20 V F = 35 V G = 50 V H = 75 V I = 80 V
	Carbon film 0.25 W or 0.33 W	70°C	5%		Polyester flat foil 10%	
	Metal film 0.25 W or 0.33 W	70°C	5%		Metalized polyester flat film 10%	
	Carbon film 0.5 W	70°C	5%		Polyester flat foil small size (Mylar) 10%	
	Carbon film 0.67 W	70°C	5%		Polysterene film/foil 1%	
	Carbon film 1 W or 1.15 W	70°C	5%		Tubular ceramic	
					Miniature single	
	Chip component				Subminiature tantalum ± 20%	

Semiconductor Layout

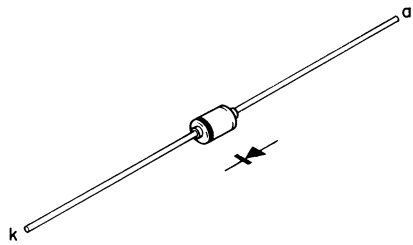

1SR35-200A

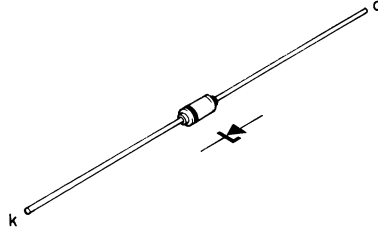

MA1150M

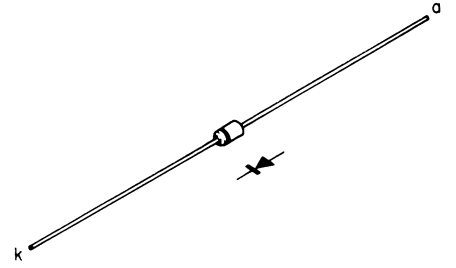

1S1555 DS448
1S2473 MA150
1S2076

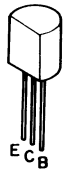

2SA933SP

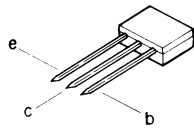
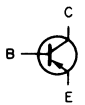

2SC2785(J,H)

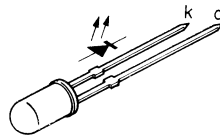

GL-5HD10

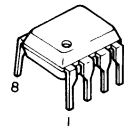

NJM4558D-D



S4VB

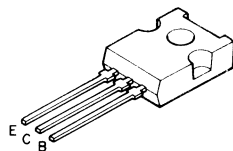
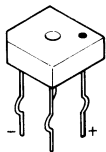

2SC3419(O,Y)

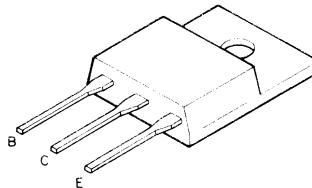

2SB686

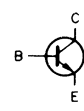
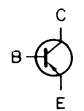

2SD716

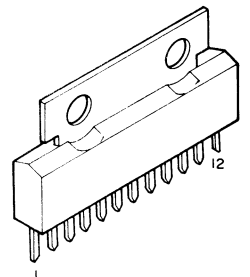

μPC1270H

SCHEMATIC DIAGRAM

R	R417 R418 R403 R404 R408 ~ R412 R415 R416 R407	RG04 R804 R803	RE52 RG01 RG03	R703 R705	R707 R730 RB01 RB02	R721 R722 R709 R710 R717 R729 R719 R723	RN01 RN03 RN51 RN05 R
C - G	RS01 RS02 RL51 RL54 RS06 RL55 RS04 RS03 RE09 RE07 RS05 RE13 RE01 RE03 RE11 RE05 RE15 RE16 RE10 RE08 R702 RE14 RE02 RE04 R704 R706 RE06 RE12 R708 RB06 RB05 R718 R720 R724 RN04 RN02 RN08 RN06	C807 C808	C701 C725 C707 C711 C706 C705	G001	C801 C806 C803 C714 C805	C727 C713	
Q - D	DL51 Q401 DL52 DL53 DL54 Q808 Q809 DL55	DL55	Q701 Q702 Q801	Q701 Q702 Q801	Q701 Q702 Q801	Q703 ~ Q706 QN05 QN06 QN03 QN04 QN51	
L - S - F	SS01-5 SS01-4 SS01-3 SS01-2 SS01-1	SS01-1	S001 F001 L001	S001 F001 L001	S001 F001 L001	L701 L702	

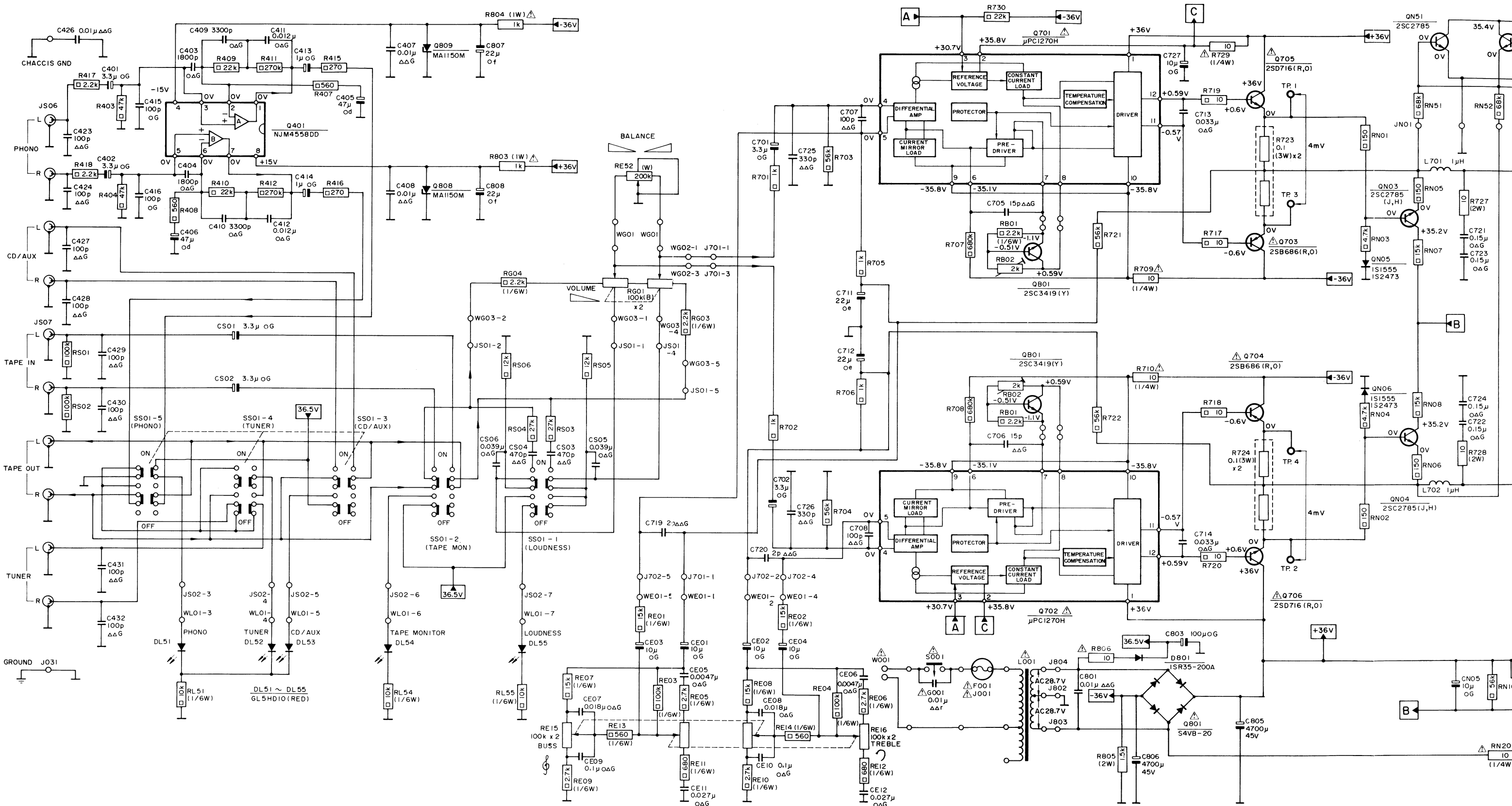

SCHEMATIC DIAGRAM

RE52 RG01 RG03	R703 R705	R707 R730 RB01 RB02	R721 R722 R709 R710	R717 R729 R719 R723	RN01 RN03 RN51 RN05 RN07	R727 RN52 RN54 RN53	RW01 RW02	R
RS03 RE09 RE07 RS05 RE13 RE01 RE03 RE11	CE05 RE15 RE16 RE10 RE08	R702 RE14 RE02 RE04 R704 R706 RE06 RE12	R708	RB06 RB05	RN04 RN02 RN08 RN06	R728 RN20 RN16 RN19 RN17	RN18 RN15 RN09 ~ RN13	C - G
C701 C725 C707 C711	C706 C705	C727 C713	C721 ~ C724 CN51	C729 ~ C730	CN05 CN04	CN03	Q - D	
CS04 CS03 CS05 C719 CE01 ~ CE04	CE05 ~ CE12 C702 C726 C708 C712	G001	C801 C806 C803 C714 C805	Q703 ~ Q706	QN05 QN06 QN03 QN04 QN51	QN52 QN13 QN15 DN01 QN12	QN10 QN11 QN09	L - S - F
Q701 Q702 QB01	D801 Q801	Q703 ~ Q706	QN05 QN06 QN03 QN04 QN51	QN52 QN13 QN15 DN01 QN12	QN10 QN11 QN09	SW01	L - S - F	
S001 F001 L001	L701 L702	SW01	L701 L702	SW01	L701 L702	SW01	L - S - F	

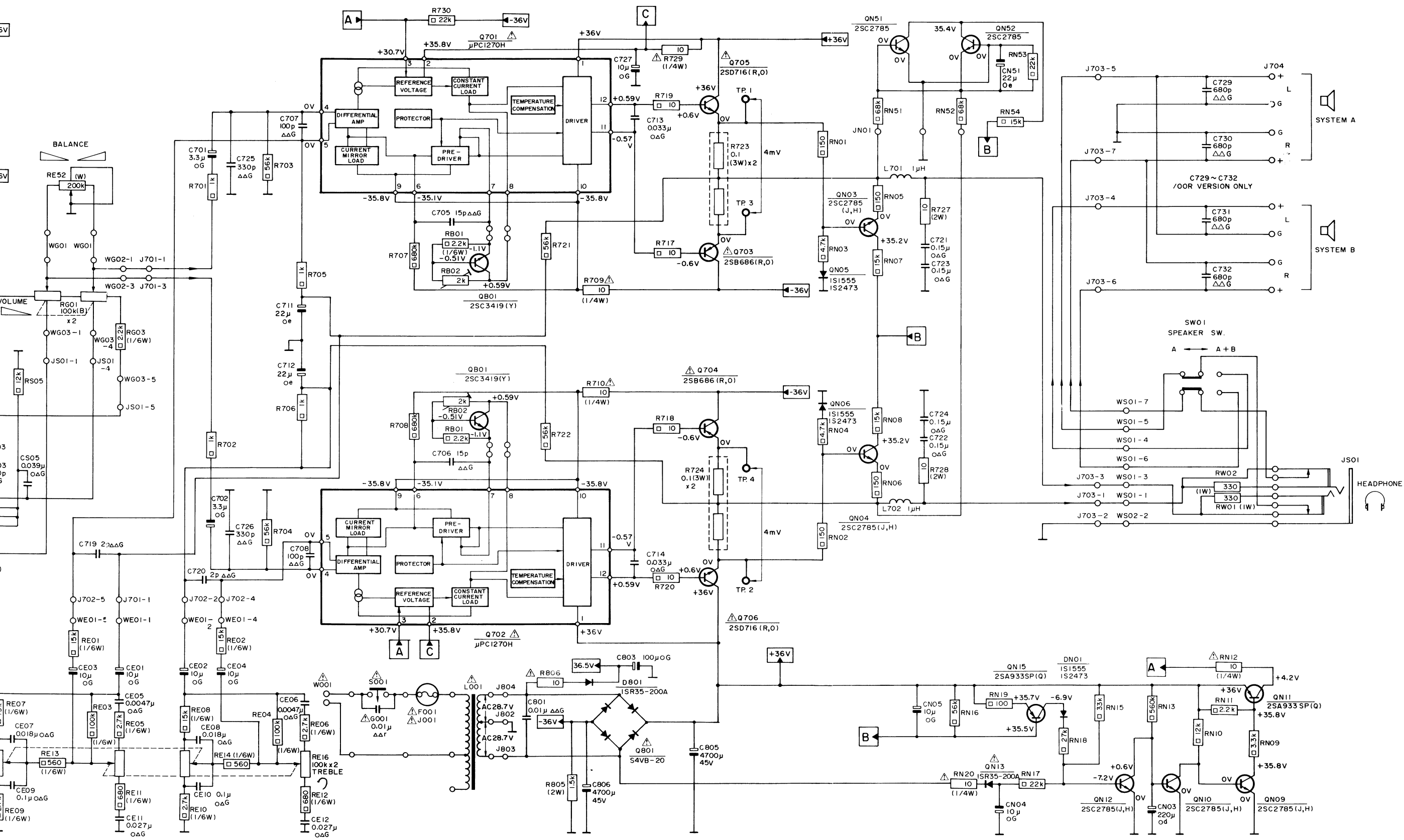

WIRING DIAGRAM

R - G				R806	R727 R728	R717	R723	R805	R707	R705	R721	R729	R703	R722	R704	R718	R706	R710	R708	R701	R702	R720	R803	R804	R417	R418	R415
C				C805 C801	C806 C803	C721 ~ C724	C719	C713	C705	C707 C701	C711 C432	C431	C727 C726	C427 ~ C430	C424	C423	C808	C807	C401 ~ C416	C409 ~ C412	C406	C405	C404	C416	C415	C414	C413
Q - D - V				Q801 QN09 ~ QN13	QN15 DN01 DB01		Q703		Q705	Q701	QN03 ~ QN06		Q704	Q702						Q706	Q809	Q808	Q401				
L - S - F - X	L001	F001					SS01-5	L701 L702	SS01-4	SS01-3		SS01-2		SS01-1													

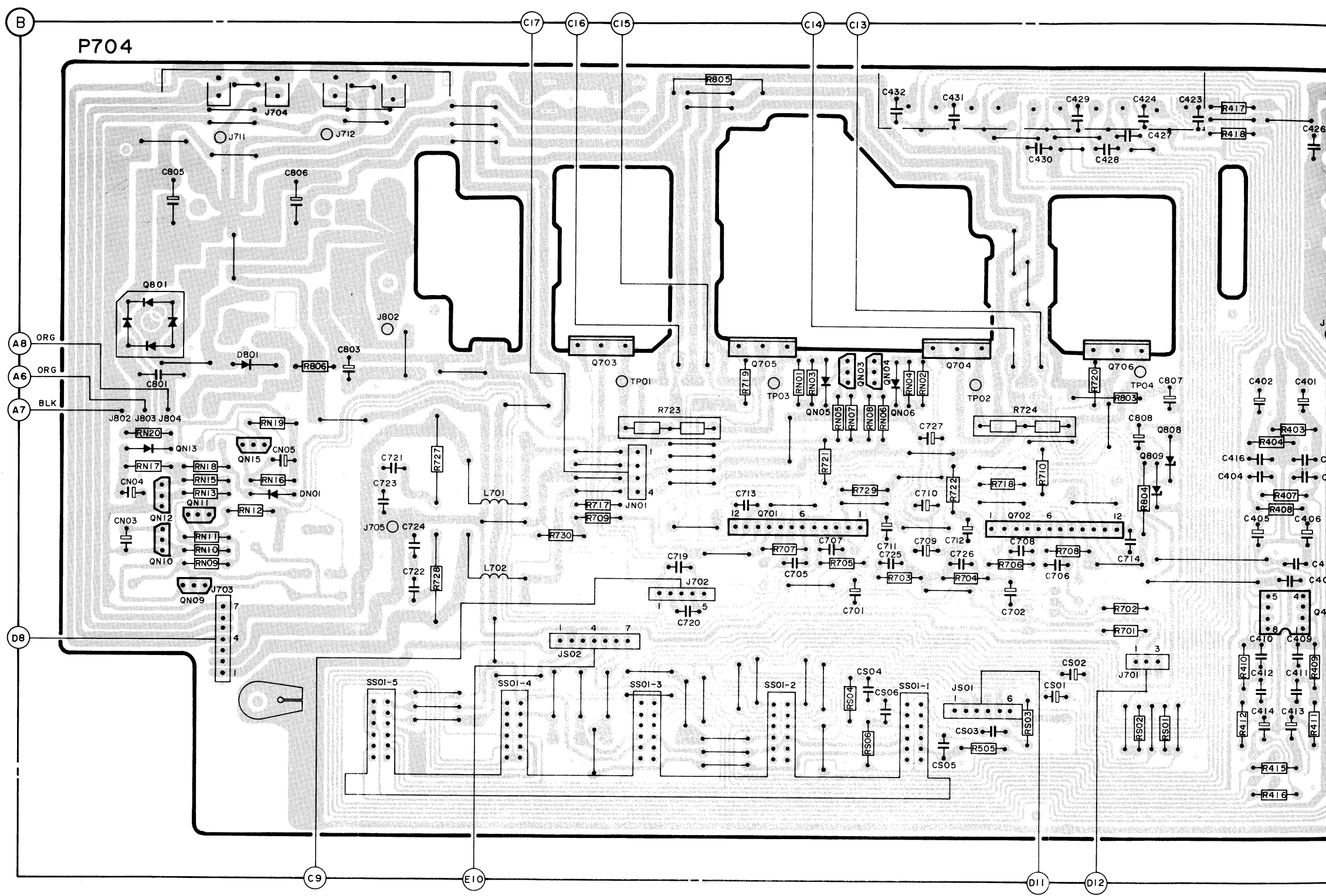
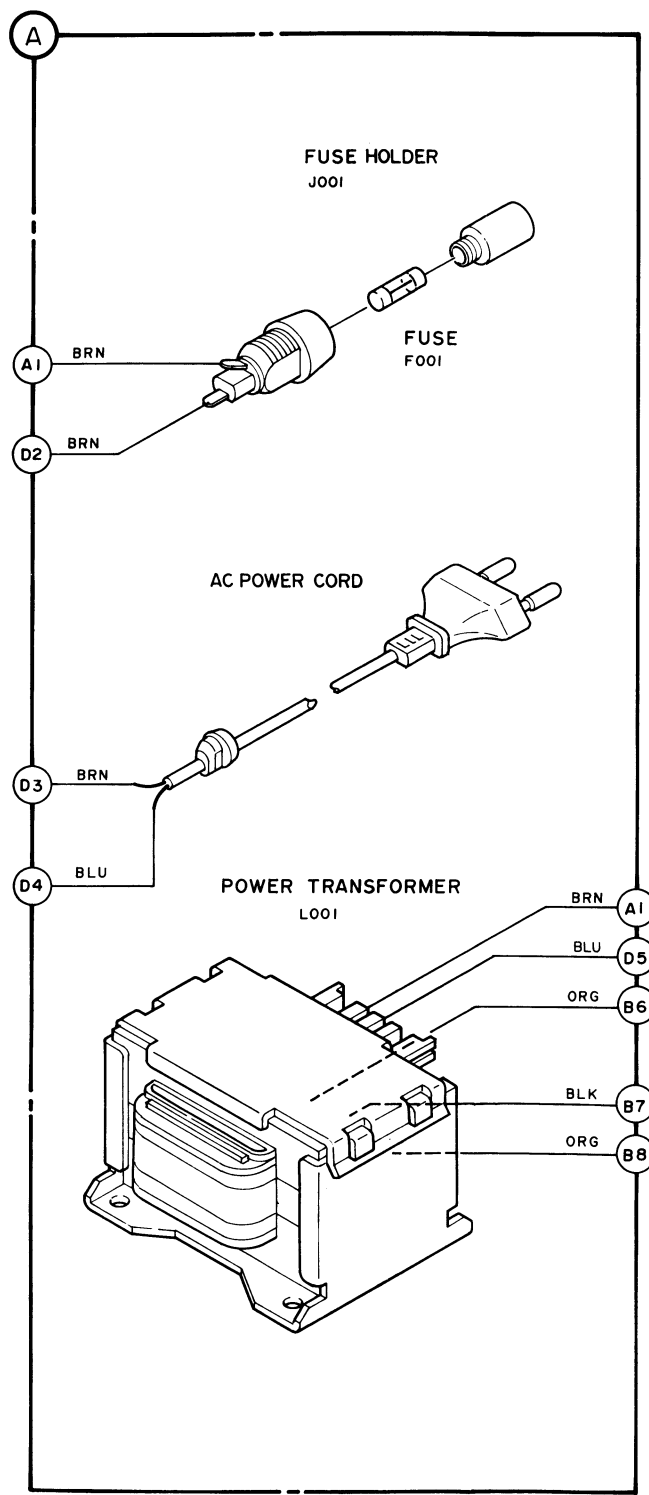

EXPLODED VIEW

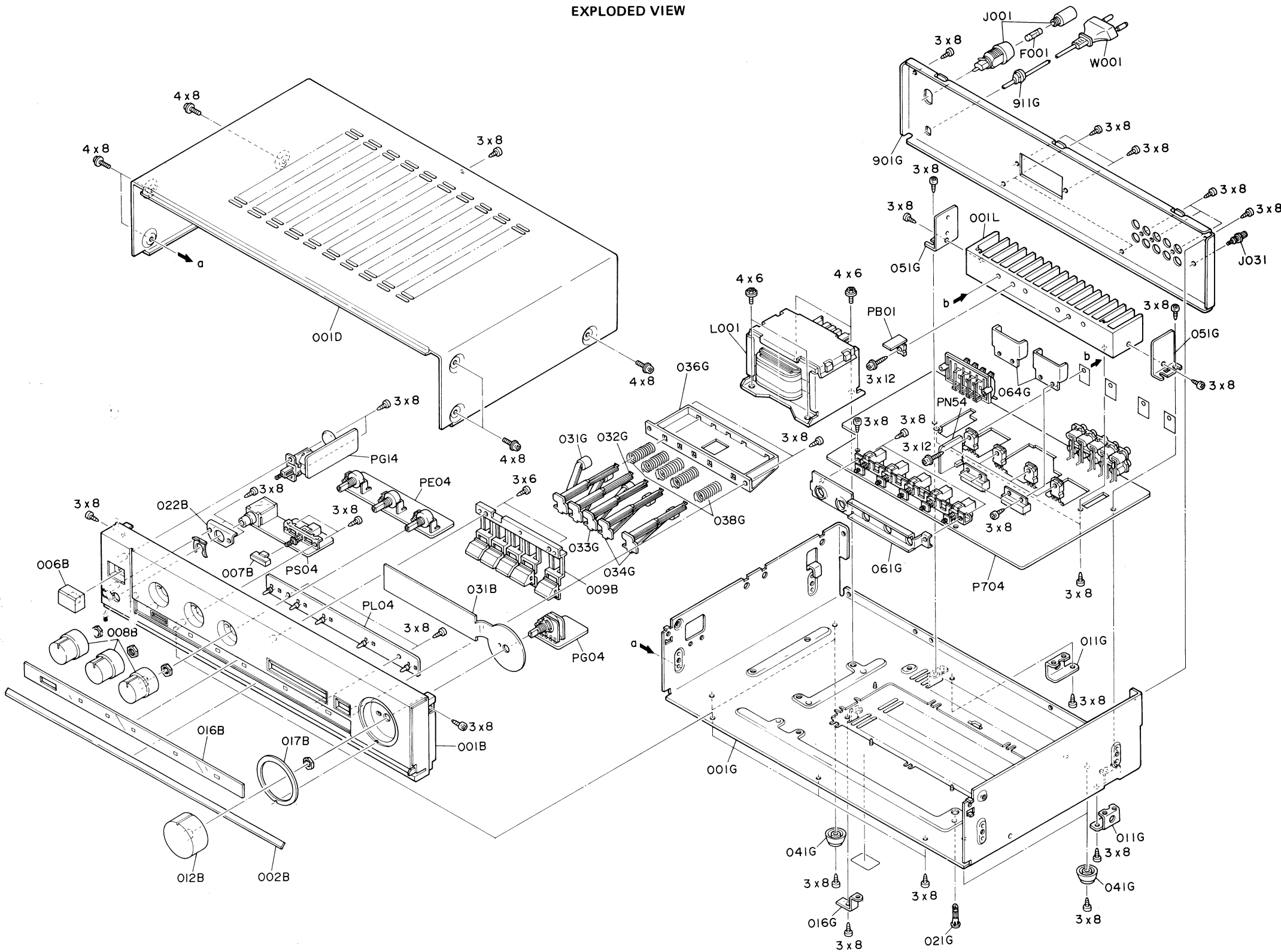

F001	4822 253 20017	012B	4822 412 20663
J001	4822 256 30233	016B	4822 454 11859
J031	4822 267 40505	017B	4822 454 11832
L001	4822 146 21178	006D	4822 502 12501
001B,002B, 016B,017B	4822 426 51092	006G	4822 500 10357
002B	4822 426 51041	031G	4822 404 60254
006B	4822 410 25074	032G	4822 404 60249
007B	4822 410 25075	033G	4822 404 60251
008B	4822 412 20974	034G	4822 404 60252
009B	4822 410 25228	038G	4822 492 42018
		041G	4822 462 40971
		911G	4822 532 51314

List of electrical parts

	C719	Cer. cap.	2 pF	50 V	4822 122 40298
	C720	Cer. cap.	2 pF	50 V	4822 122 40298
	C801	Cer. cap.	0.01 μF	500 V	4822 122 30043
	C805	Elect. cap.	4700 μF	45 V	4822 124 21597
	C806	Elect. cap.	4700 μF	45 V	4822 124 21597
	G001	Cer. cap.	0.01 μF	250 V	4822 122 40305
	RB02	Trimm. res.	2k		4822 100 20191
	RE15	Var. res.	tone 100k		4822 100 20536
	RE16	Var. res.	tone 100k		4822 100 20536
	RE52	Var. res.	Bal. 200k		4822 100 20534
	RG01	Var. res.	100k		4822 100 20535
	RN12	Fuse res.	10E ¼ W		4822 116 60314
	RN20	Fuse res.	10E ¼ W		4822 116 60314
	RW01	Safety res.	330E 1 W		4822 111 50474
	RW02	Safety res.	330E 1 W		4822 111 50474
	R709	Fuse res.	10E ¼ W		4822 116 60314
	R710	Fuse res.	10E ¼ W		4822 116 60314
	R723	Res compo.	0.1E		4822 111 90966
	R724	Res compo.	0.1E		4822 111 90966
	R727	Safety res.	10E 2 W		4822 111 90726
	R728	Safety res.	10E 2 W		4822 111 90726
	R729	Fuse res.	10E ¼ W		4822 116 60314
	R803	Safety res.	1k ¼ W		4822 116 60331
	R804	Safety res.	1k ¼ W		4822 116 60331
	R805	Safety res.	1.5k 2 W		4822 116 60339
	R806	Fuse res.	10E ¼ W		4822 116 60314
	2SC3419Y				4822 130 60117
	2SC2785 J, H				5322 130 42052
	2SA933SP Q				4822 130 42482
	2SB686 R,O				4822 130 42485
	2SC2785 J,H				5322 130 42052
	2SD716 R,O				4822 130 42487

	MPC1270H	
	NJM4558DD	
	1S1555	
	MA1150M ½ W	
	S4VB-20	
	1SR35-200A	
	1S1555	
	GL5HD10 red	
	L701	Coil
	L702	Coil
Miscellaneous		
	JS01	Head
	JS06	Terr
	JS07	Terr
	SS01	Push
	SW01	Push
	F001	Fuse
	J001	Fuse
	J031	Group
	J704	Spec
	L001	Tran
	S001	Push

